

heinze

Petromax and Geniol kerosene pressure lanterns

Type 829 Rapid 500 CP (400 watts) . Type 830 Rapid 150 CP (100 watts)

Operation manual

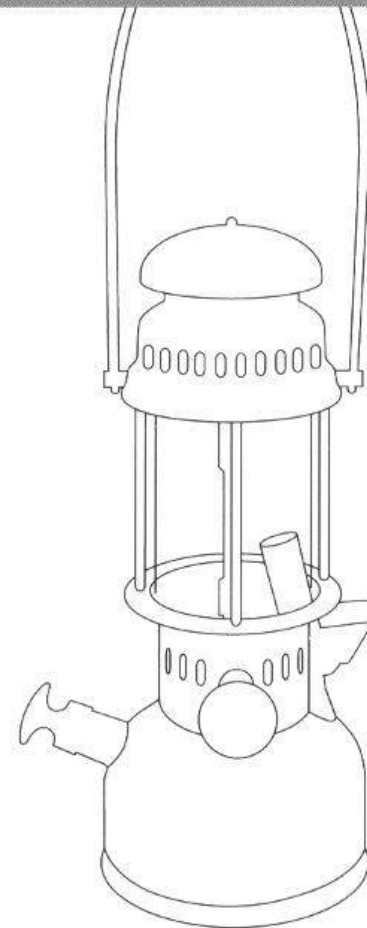

ORIGINAL
Petromax

Geniol

Content	
Warning notices	3 - 4
The kerosene pressure lantern	4 - 5
1 Contents on delivery	6 - 7
tool descriptions:	
» spanner with gauge (66)	8 - 10
» manual cleaning needle (180)	11
» needle key (119)	12 - 13
2 Initial operation	14 - 27
3 Frequently asked questions and malfunctions	28 - 32
4 Technical support	33
5 Repairs . Returns	34
6 List of spare parts	35 - 39

Warning notices

1. Remove transportation lock above and below the glass cylinder. In order to do so dismount the upper part of the lantern (123) by loosening the knurled head screws on the sides and carefully lifting the upper part and inner casing (117) off upwards.
2. Fill, assemble and operate the lantern outdoors only.
3. Never place the lantern on delicate surfaces such as table cloths, place mats or wooden furniture tops.
4. Keep a safety distance to inflammable or heat sensitive objects at all times.
5. Please only use class A III kerosene with a flashpoint of 57 °C or higher.

We recommend the original Heinze kerosene: 1 litre of purified kerosene, class AIII, Heinze article 20100.

6. Never use scented paraffin, petrol, spirit or other easily inflammable fuel.
7. Please ensure a sufficient pre-heating time of 90 seconds minimum, otherwise the kerosene may not evaporate and leak from the nipple (danger of flames!).
8. Release pressure completely after every use.
9. Make sure that nipple and nozzle are securely tightened before every use.
10. Never lean over the lantern during initial operation or use.
11. Keep away from children.
12. Never refill kerosene whilst lantern is in use.
13. Never leave burning lantern unattended.

14. Repairs, maintenance or technical operations may only be conducted by or under the instruction of authorised members of the manufacturer's staff.
We assume no liability for incorrect use or misappropriation.

The kerosene pressure lantern

The first pressure lantern to be fuelled with kerosene gas was developed in Berlin in 1910 by the engineer Max Graetz. He and his brother Adolf Graetz had taken over the management of the family business Ehrich & Graetz. Next to developing burners for incandescent light, electric bulbs and various electric goods such as the Graetz radio, Max Graetz engaged in the construction of a powerful lantern fuelled with kerosene. The result of his endeavours was the world-famous Petromax, which is named after its inventor. Today Petromax is a registered trademark of Schott glass manufacturers in Mainz, Germany.

The brand name Geniol roots in the Twenties when it first appeared on a series of razor blades that Heinze produced in Solingen, Marburg, Niedersfeld and later in Wiemringhausen.

Other small hardware goods followed, later yet paraffin cookers and kerosene lanterns. The brand name Geniol is a registered trademark of Heinze GmbH & Co, Wuppertal, Germany.

The initial operation of a kerosene lantern resembles a small ceremony. Whereas all you need to do with its wired relatives is press a switch, the start-up of a paraffin lantern requires much time and attention. Please read this manual carefully and refrain from starting up your lantern by principle of trial & error.

Max Graetz



1 Contents on delivery

Please ensure that contents are complete and all parts are intact. The content of the delivery may vary depending on type and year of manufacture. Your specialist dealer or the manufacturer's sales catalogue will inform you about the current contents of your lantern type.

The contents of delivery listed below are status quo of 09/2003. Subject to alterations.

1 Pressure lantern

Petromax _____

Geniol chrome _____

Geniol brass _____



1 gas mantle (4)

(Geniol 150 CP: 2 gas mantles #4) _____



1 spanner with gauge (66) _____



1 manual cleaning needle (180) _____



1 needle key (119) _____



1 pressure gauge seal (11) _____



1 nipple (50) _____



1 needle (68) _____



1 funnel with sieve (165) _____



1 filling can (67) _____



Should parts be missing or out of order, please contact your dealer or the manufacturer's customer service.

Tool descriptions

Spanner with gauge (66) 

Use the Spanner 66 for following duties:

1. Adjusting the mixing tube

Remove the upper part of the lantern (123) by loosening the knurled head screws on the sides and carefully lifting the upper part off upwards. Please ensure that the kerosene container is not under pressure. If necessary release any existing pressure by turning the bleeder screw on the pressure gauge (149). Turn the hand wheel (111) anti-clockwise until the arrow is pointing vertically down. Hold the spanner between the nipple (50) and the mixing tube (33) (**illustration 1.1.1**) as shown and check spaces as follows:

Petromax 500 CP: The distance between the nipple and the mixing tube is correct if it complies with the second level of the gauge on the spanner (**see illustration**).



Geniol 150 CP: To determine the correct distance on the Geniol 150 HK lantern do not use the spanner. The mixing tube is attached correctly, when secured in an up-most position.

Should the distance between the nipple and the mixing tube be an other than required, please proceed as follows:

Petromax 500 CP: Loosen the screw (21) on the other side of the inner casing (117) with a screw driver so much that the mixing tube can be moved up and down with ease. Adjust the mixing tube to the correct position and secure it by tightening the screw.

Geniol 150 CP: Loosen both hexagonal nuts of the inner casing (**illustration 1.1.2**). Move the mixing tube to an up-most position then tighten both nuts again.

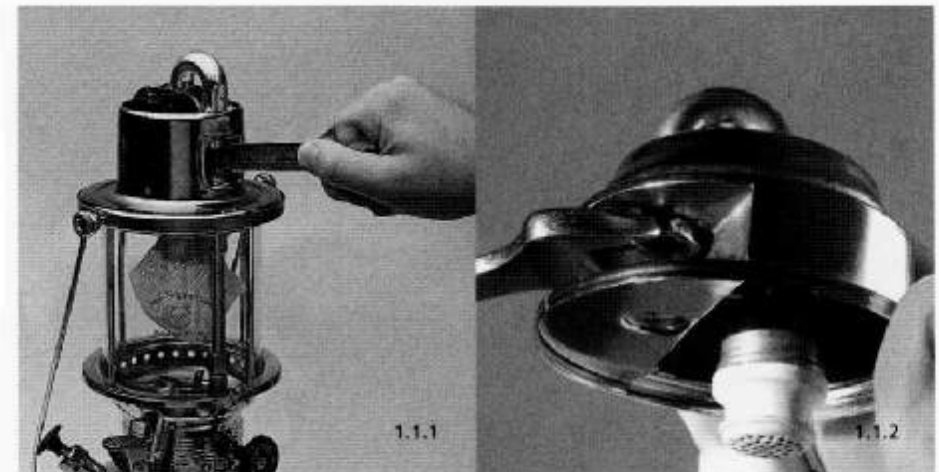

2. Tightening the nipple (50)

Remove the upper part of the lantern (123) by loosening the knurled head screws on the sides and carefully lifting the upper part off upwards. Make sure the kerosene container is not under pressure. If necessary release any existing pressure by turning the bleeder screw on the pressure gauge (149). Remove the inner casing (117) and the glass cylinder (74). The inner casing ought to be placed next to the lantern on the glass cylinder for service in order to protect the gas mantle (illustration 1.2.1). This also protects the gas mantle from any wind. For more stability hold the upper part of the vaporizer (152) with one hand and tighten the nipple holding the spanner in the other hand (illustration 1.2.2). Assemble parts in opposite order.

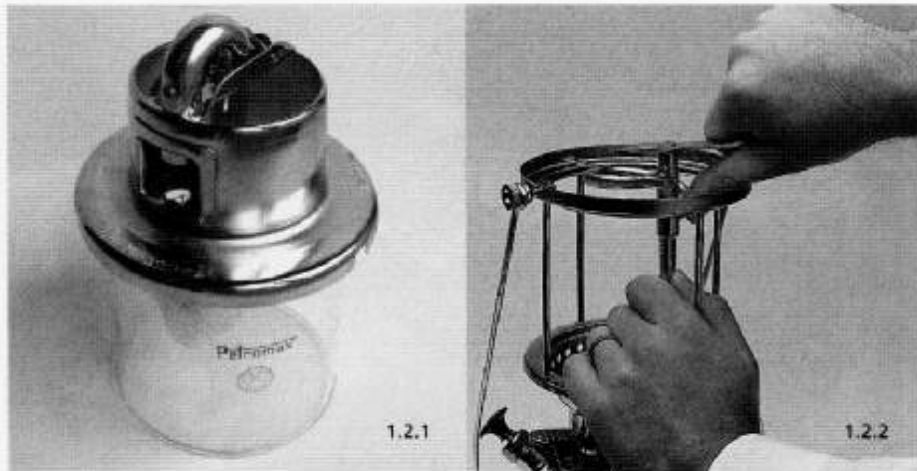

Manual cleaning needle (180)

Use the manual cleaning needle to clear the nipple (221) of the rapid pre-heater and the three holes of the connecting piece (225) below. Please ensure that the kerosene container is not under pressure. If necessary release any remaining pressure by turning the bleeder screw on the pressure gauge (149). Open the rapid pre-heater by moving the toggle switch (223) to a downward position. Then feed the wire on the manual cleaning needle through the bore hole in the nipple several times (illustration 1.2.3).



Needle key (119) _____ |

Use the needle key (119) with its triangular socket to change the needle (68). Remove the upper part of the lantern (123) by loosening the knurled head screws on the sides and carefully lifting the upper part off upwards. Please ensure the kerosene container is not under pressure. If necessary release any existing pressure by turning the bleeder screw on the pressure gauge (149). Remove the inner casing (117) and the glass cylinder (74). The inner casing ought to be placed next to the lantern on the glass cylinder for service in order to protect the gas mantle (illustration 1.2.4). This also protects the gas mantle from any wind. For more stability hold the upper part of the vaporizer (152) with one hand and tighten the nipple (50) holding with the spanner in the other hand (illustration 1.2.5). Now unscrew the needle with the needle key (see illustration) and replace it with a new needle accordingly. Assemble parts in opposite order.

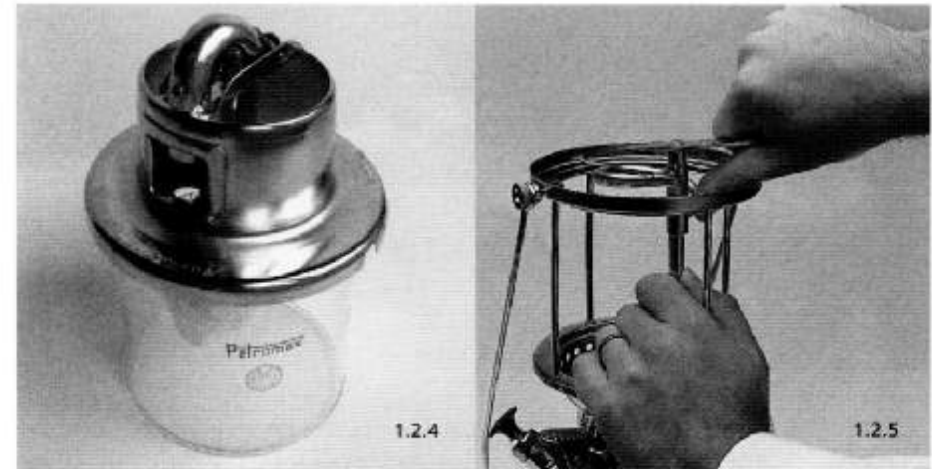

2 Initial operation

2.1 Presettings

Following presettings are essential for initial operation. Please make sure that:

- a. the nipple (50) is tight. Please refer to the description of the spanner with gauge in the tools chapter on how to do so.
- b. the screw on the pressure gauge is tight.
- c. the gas mantle is in order and attached above the lower bulge of the nozzle.

Mounting the gas mantle

Remove the upper part of the lantern (123) by loosening the knurled head screws on the sides. Carefully lift the upper part off upwards. Now remove the inner casing (117) and carefully place it on a pad as shown. Stretch the opening of the gas mantle (4) with your fingers and place it over the lower bulge of the nozzle (3) (**illustration 2.1 b and 2.1 c**). Now pull the opening tight using both strings and fasten string ends with a knot. Cut strings to a length of approx. 2 cm. Put the inner casing back on the frame with bail (121) making sure that the round opening of the inner casing chamber locks into place on the nipple (50).

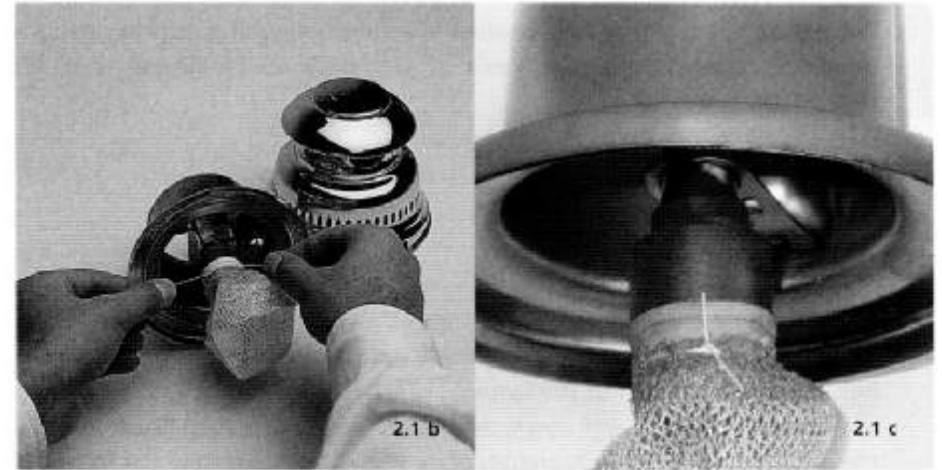

Notice for Petromax 500 CP mantle support

The mantle support available as an accessory for Petromax 500 CP (Heinze article 21080) ensures maximum stability even under adverse conditions. The double-sided attachment of the special double-tie gas mantle (Heinze article 12204) increases durability considerably.

The mantle support may only be used in connection with specifically designed double-tie gas mantles available as a set with three double-tie gas mantles (Heinze article 21000).



Mounting mantle support and double-tie gas mantle

Remove the upper part of the lantern (123) by loosening the knurled head screws on the sides. Carefully lift the upper part off upwards. Now remove the inner casing (117) and carefully place it on a pad. Unscrew the nozzle (3) from the mixing chamber (34). Place the base of the mantle support with the countersunk hole on the mixing chamber, in such a way that the bail faces away from the mixing chamber. Locate the support bail and mixing chamber in screwing the nozzle on from below. Now stretch the larger upper opening of the double-tied gas mantle (2) with your fingers and place it over the bottom bulge of the nozzle (see illustration). Now pull the opening tight using both strings and fasten ends in a knot. Cut strings down to a length of approx. 2 cm. Now push the small opening of the double-tied gas mantle (without strings) halfway up the ceramic piece of the mantle support (see illustration).

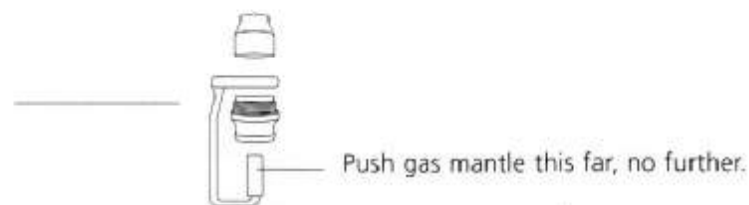

Please note!

Broken gas mantles need to be replaced immediately. Even very small tears in the material may cause flames that can damage the lantern.

Please use original Heinze gas mantles only:

Petromax 500 CP gas mantle: Heinze article 12213

Geniol 150 CP gas mantle: Heinze article 12210

Petromax 500 CP double-tied gas mantle: Heinze article 12204 (only to be used with the original Heinze mantle support).



Original Heinze gas mantles are asbestos and thoriumfree. Authorized by the responsible German Federal Office.

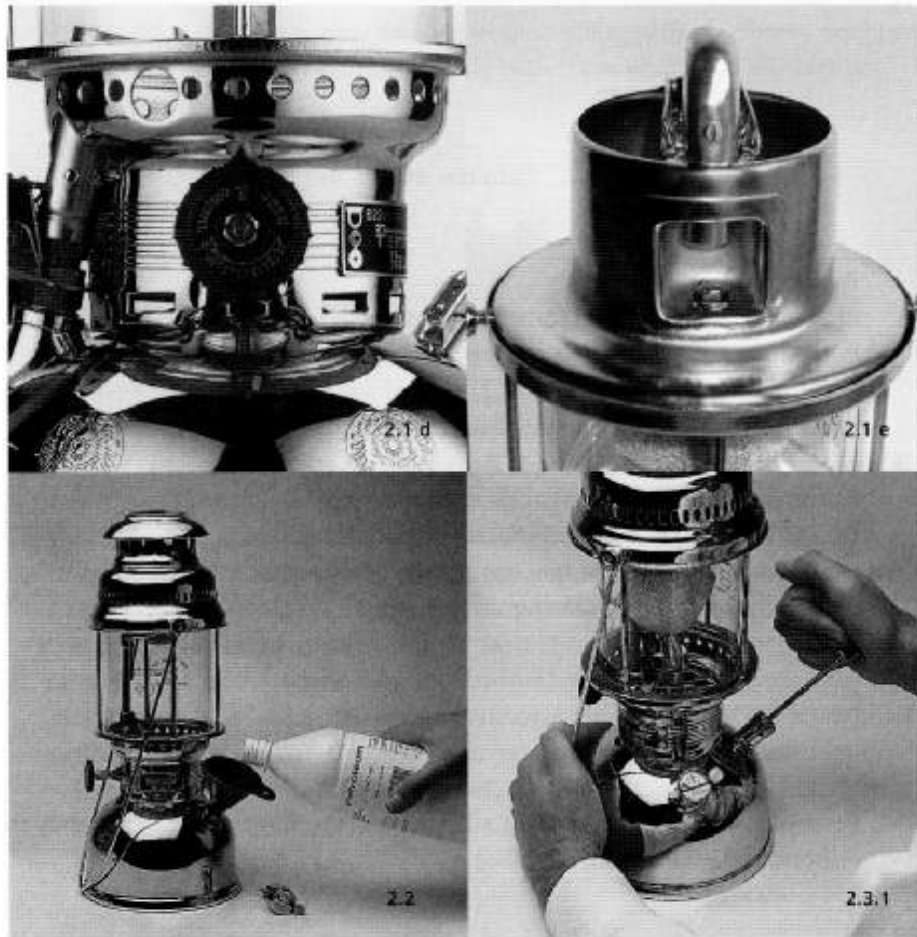

- d. the hand wheel (111) points upwards, i.e. the container is shut. **ATTENTION!** On delivery the arrow on the hand wheel points downwards (illustration 2.1 d).
- e. The inner casing (117) is locked onto the nipple (50) correctly (illustration 2.1 e).
- f. The hood (123) is fitted and secured with the knurled head screws on the sides.

2.2 Filling in kerosene

Unscrew the manometer (gauge 149) and fill the container with purified kerosene using the funnel. The container is full when the kerosene surface is level with the bottom line of the fill nozzle (illustration 2.2).

Petromax 500 CP lantern: 1 litre

Geniol 150 CP lantern: 0,375 litre

Now replace the manometer making sure the manometer screw is shut.

2.3 Building up pressure

Release the lock on the hand pump by turning the pump knob (40) by a quarter revolution. Hold the lantern close to your body for maximum leverage. For better stability grasp the container with one hand and the pump knob with the other (illustration 2.3.1). Now build up pressure with full, even strokes until the pressure gauge reaches the red line (approx. 2 bar).

Should you feel no pressure building up, detach the pump cap (42) by turning it anti-clockwise and remove the whole pump piston. Ensure that the o-rings at the base of the pump piston are intact and lubricate them with a little grease if necessary. Then re-mount the pump piston and try building up pressure again.

In case your lantern has a pump mechanism with a leather sleeve instead of the o-rings described above, please dismount the pump piston (6) and proceed as follows: grease the leather and bend the brim slightly outwards.

An air pump adapter (Heinze article 20405) is available on request for the use of extern air pumps. It can be attached to the pump tube instead of the pump piston (6) (illustration 2.3.2).



2.4 Pre-heating the lantern

Pre-heating

In order to attain the operating temperature necessary to cause kerosene to evaporate the vaporizer (115) must be pre-heated. This can be done in two ways: Either using the pre-heating cup (35) and spirit, or the rapid pre-heater (226). The advantages of either method are as follows:

Method "pre-heating cup"

- No pump action necessary during pre-heating
- One pump is sufficient for initial operation
- Little noise development
- All together an easy and comfortable start-up method

Method "rapid pre-heater"

- No second fuel necessary
- Shorter pre-heating period of approx. 90 seconds

The following passage describes how to use both methods:

Pre-heating the vaporizer using the pre-heating cup and spirit:

Fill the pre-heating cup in the base of the vaporizer to the brim with spirit through the hole in the frame (121) using the filling can (**illustration 2.4 a**). Light the spirit with a match or a lighter from the outside and carefully let the content of the cup burn down. When the flame has gone out re-fill the cup up to the brim and repeat the pre-heating process. Just before the second filling has burnt down, turn the hand wheel anti-clockwise until the arrow on the hand wheel points down vertically. The container is now open. The kerosene flows through the nipple where it turns to gas which then mixes with air in the in the space between the nipple (50) and the mixing tube (33). The kerosene-air-mixture flows through the mixing tube, the mixing chamber and the nozzle into the gas mantle. In doing so it creates a hissing noise typical for kerosene pressure lanterns. The gas mantle will start to glow.

Pre-heating the vaporizer with the rapid pre-heater

Please note!

A new gas mantle must anneal before use. In order to do so, please proceed as follows: build-up sufficient pressure (see paragraph "building up pressure") then open the rapid pre-heater (226) by moving the toggle switch (223) to a downward position. Ignite the jet of kerosene flowing through the nipple with a lighter or a match (**illustration 2.4 b**). This will create a pre-heating flame inside the lantern directed towards the upper part of the vaporizer (152) and the gas mantle.

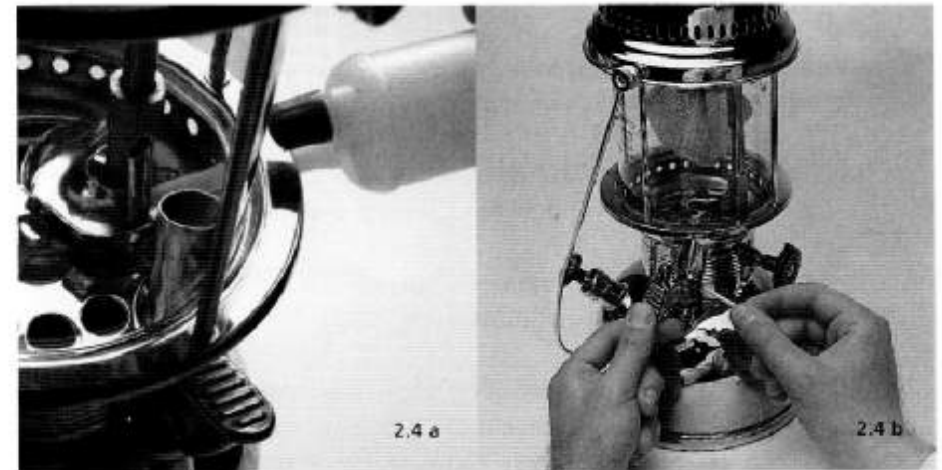

Shut the toggle switch after five seconds and let the gas mantle anneal for two to three minutes. The gas mantle is ready for use when it is contracted. Please note that due to the fact that its consistency has changed, the gas mantle is now more easily damaged.

Open the rapid pre-heater (226) by moving the toggle switch (223) to a downward position and ignite the kerosene jet flowing from the nipple with a lighter or a match (**illustration 2.4 b**). This will create a pre-heating flame inside the lantern directed towards the upper part of the vaporizer (152) and the gas mantle. Please ensure a minimum pre-heating time of 90 seconds at all times (see warning notices).

CAUTION! To avoid a loss of pressure please keep pumping steadily during pre-heating maintaining a pressure of approx. 2 bar.

After 90 seconds of pre-heating (the pre-heating process is not yet completed!):

1. Please check pressure! It should not fall short of 2 bar (**illustration 2.4.1**).
2. Turn the hand wheel (111) anti-clockwise until the arrow points down. The gas mantle will start to glow (**illustration 2.4.2**).

Reason: The container is now open. Kerosene flows through the nipple where it evaporates. The kerosene gas then mixes with air in the space between the nipple (50) and the mixing tube (33). This kerosene-air-mixture flows through the mixing tube, the mixing chamber and the nozzle into the gas mantle. In doing so it creates a distinct hissing noise typical for the kerosene pressure lantern.

3. Now close the toggle switch (**illustration 2.4.3**) and pump for maximum pressure (2 to 3 bar). It is vital to proceed in this order for a proper functioning.

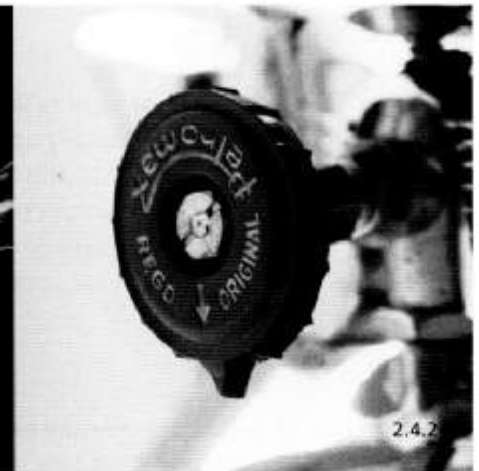
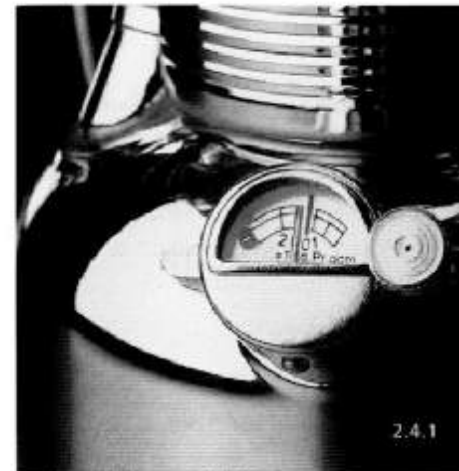

2.5 Extinguishing the lantern

Put the lantern's light out by turning the hand wheel (111) clockwise until the arrow on the wheel points vertically upwards. The container is now closed. The lantern may continue glowing for a while due to remains of kerosene gas in the vaporizer. A drop in temperature may cause the vaporizer to make noises that should stop as soon as the pressure is released. After use please release any pressure by loosening the bleeder screw on the pressure gauge (149).

2.6 After use

It is vital to ensure that any pressure is released after use by opening manometer screw. Due to its high operating temperature the lantern should be left to cool for a minimum 30 minutes before carrying out any service duties.

We recommend you store and transport your kerosene pressure lantern in an original Heinze storage and transport box. Following types are available:

Geniol 150 CP:

Steel, galvanised, with rubber foam padding and hook fastener.
Heinze article 21188

Petromax 500 CP:

Steel, galvanised, the rubber foam padding and hook fastener.
Heinze article 21190 (illustration 2.6.1)

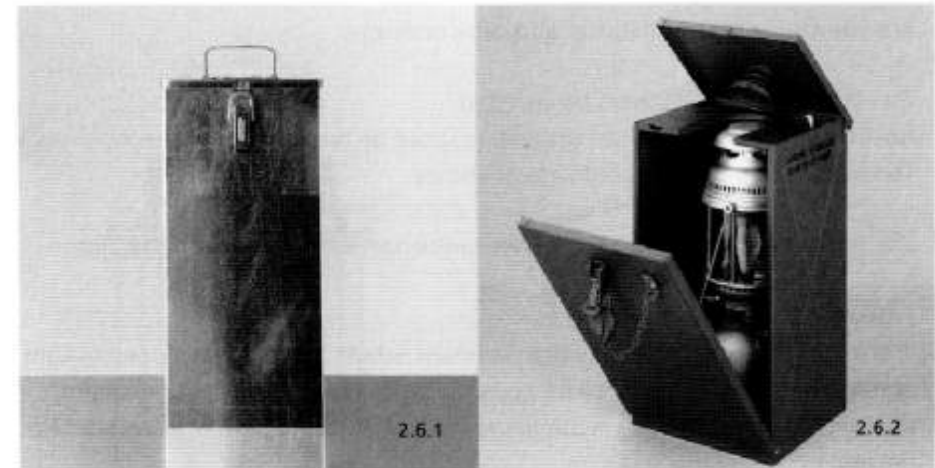

Original NATO-version, steel, bronze-green powder-coated, with spring bearing, cross stabilisers and a compartment for spare parts. Heinze article 21150 (illustration 2.6.2)

Note to type 21150: This type is not standard ware. Its production is dependant on NATO stock orders. Please inquire about present supplies.

3 Frequently asked questions and malfunctions

3.1 Can the lantern's brightness be adjusted?

No. The intensity of light can only be adjusted by reducing or increasing pressure. The hand wheel does not regulate brightness.

The following accessories allow you to influence light intensity or direction:

Enamelled glass cylinder (matt)

The matt version of the highly heat resistant Schott Suprax glass disperses light evenly and cushions the lantern's powerful light. As ignition is not apparent through the matt glass we recommend the article to users already familiar with the lantern's technology.

Glass cylinder Schott Suprax enamelled (matt) for Petromax 500 CP:

Heinze article 21110 (**illustration 3.1.1**)

Glass cylinder Borosilicate sandblasted for Geniol 150 CP:

Heinze article 21040

Reflector

Not only does the reflector look good, it directs the light downwards without creating shadows thus protecting the eyes from being blinded.

Reflector, chrome-plated steel, for Petromax 500 CP: Heinze article 21360

(**illustration 3.1.2**)

Reflector, chrome-plated steel, for Geniol 150 CP: Heinze article 21250

Reflector, gold-plated steel, for Geniol 150 CP: Heinze article 21240



Side reflector

The side reflector consists of high-grade steel polished on both sides. The polished surface bundles the light and casts it in one direction. The semicircular shield can be used to create a cosy indirect lighting e.g. by placing the lantern with the open side facing a wall.

Side reflector, polished stainless steel, for Petromax 500 CP: Heinze article 21290 (illustration 3.1.3 and 3.1.4)

Side reflector, polished stainless steel, for Geniol 150 CP: Heinze article 21380



- 3.2 Flames appear on the upper part when opening the lantern.
Pre-heating time was insufficient. Extinguish the lantern and repeat the set-up procedure with a minimum pre-heating time of 90 seconds.
- 3.3 A corona of flames appears around the gas mantle.
A circle of flames surrounding the gas mantel is likely to have one of the following three causes:
 1. The nipple (50) is not securely fastened.
What to do: tighten the nipple with the spanner.
How to do so: see description of the spanner in the contents chapter
 2. The nozzle (3) is not securely fastened.
What to do: tighten the nozzle.
How to do so: Dismount the upper part of the lantern (123) by loosening the knurled head screws and carefully lifting the upper part off upwards. Now remove the inner casing (117) and carefully place it on a pad. Hold the nozzle gently above the upper bulge and turn it clockwise to fix it without touching the gas mantle. Assemble in reversed order.
 3. The mixing tube screw is not adjusted correctly.
What to do: Adjust the mixing tube screw with a screwdriver.
How to do so: Insert the screwdriver through the hood as shown and turn the mixing tube screw a quarter revolution to the left. Watch the flame while doing so to achieve the best result. Usually the slot in the mixing tube screw should be righted.

3.4 The lantern smokes.

What to do: Ensure nipple # 50 and / or nozzle # 3 are tight. Clear the nipple and improve the flame if necessary by turning the hand wheel repeatedly.

3.5 The rapid pre-heater fails to ignite.

If the rapid pre-heater (226) fails to ignite properly the operating pressure may be too high or too low. In most cases the pressure is too high blowing the flame of the match or lighter out. Should this be the case please open the toggle switch and continue trying until the pressure has dropped. A second cause may be a blocked nipple (221). In this case please clear the nipple as noted in the description of the "manual cleaning wheel" in the chapter "content on delivery".

3.6 What do the abbreviations "HK" and "CP" mean?

Both abbreviations define the pressure lantern's lighting power. "HK" is short for the German term "Hefner Kerzen", "CP" stands for the international denotation "Candle Power". 1 watt equals approx. 1,25 HK/CP. The lower the power is, the greater the aberration from this formula.

3.7 How often can the gas mantle be used?

As long as it is intact the gas mantle may be used indefinitely. The durability of the gas mantle is largely dependent on the way the lantern is used and treated. Frequent shocks due to use for outdoor activities or travel will diminish durability.

4 Technical support

Should you have queries concerning the operation of your Petromax lantern or encounter any formal or functional faults, please contact your specialist dealer or phone the manufacturer:



5 Repairs . Returns

In order to avoid delays in processing your request we kindly ask you for a notification of dispatch prior to sending your lantern to the manufacturers for service or repairs.

Send your repairs and returns to:



Germany

Before sending:

1. Ensure the kerosene container is empty.
2. Remove the used gas mantle.
3. Dismount the glass cylinder to avoid damage during transport.
4. Do not use the product box as sole packaging for dispatch. It is essential to pack the lantern in an additional, sturdy covering box.
5. Please ensure the return is sent "carriage paid". We do not accept freight forward deliveries.

6 List of spare parts

- | | | | |
|-----------|--------------------------------|------------|---------------------------|
| 3 | nozzle | 50 | nipple |
| 4 | gas mantle | 66 | spanner with gauge |
| 6 | pump piston complete | 67 | filling can |
| 10 | pump valve complete | 68 | needle |
| 11 | washer for pressure gauge | 74 | glass cylinder |
| 14 | screw for centre bottom plate | 83 | valve washer |
| 17 | valve core with screw | 90 | lead washer |
| 18 | pump valve spring | 101 | conducting rod upper part |
| 20 | clip | 102 | counter nut |
| 21 | screw for clip | 103 | conducting piece |
| 22 | cross-bar | 104 | conducting rod complete |
| 33 | mixing tube | 105 | excentre |
| 34 | mixing chamber | 107 | nipple for excentre |
| 35 | pre-heating cup | 108 | graphite packing |
| 37 | pump ring, small | 111 | hand wheel |
| 38 | pump ring, large | 112 | nut for wheel |
| 39 | pump conducting piece complete | 113 | sleeve nut for excentre |
| 40 | pump knob | 114 | excentre complete |
| 41 | disc | 115 | vaporizer complete |
| 42 | pump cap | | |
| 43 | pump piston rod | | |
| 44 | spring for pump | | |

- 117 inner casing
- 118 container without fittings
- 119 needle key
- 120 container complete
- 121 frame with bail
- 122 centre bottom plate
- 123 hood with top
- 148 upper part complete**
- 149 manometer
- 152 vaporizer upper part
- 153 vaporizer lower part
- 165 funnel with sieve
- 180 cleaning needle
- 187 sieve for rapid pre-heater
- 191 valve bar
- 193 valve washer
- 194 valve spring
- 195 valve shell
- 196 vaporizer valve complete
- 220 flame protecting tube

- 221 nipple for pre-heater
- 222 nut for nipple
- 223 toggle switch complete
- 225 connecting piece complete
- 226 rapid pre-heater, complete**
- 229 socket with screw

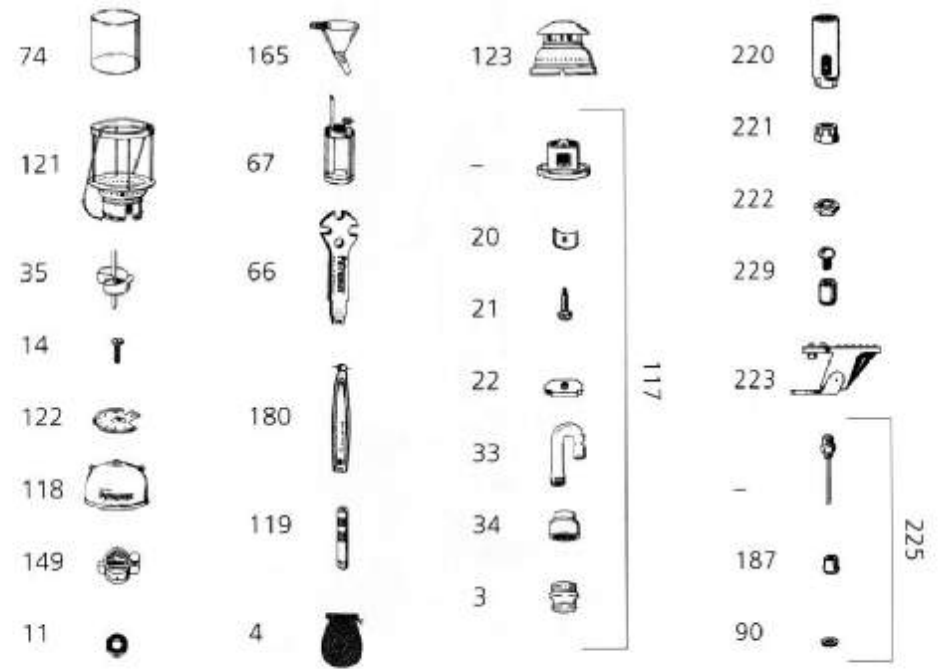

115

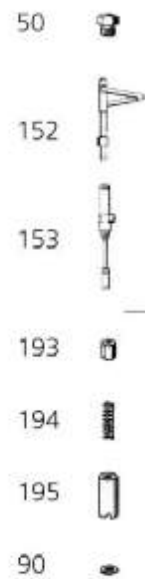

196

115



104

114

6

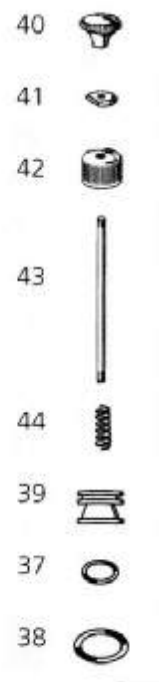

6.

10

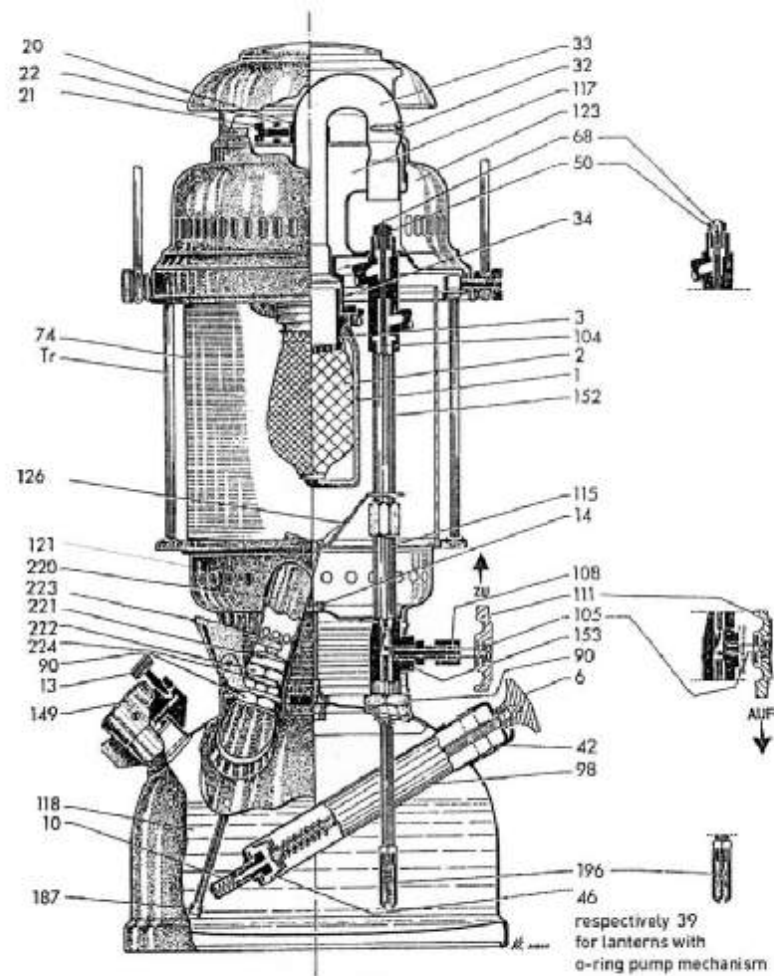
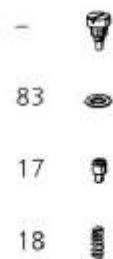

respectively 39
for lanterns with
o-ring pump mechanism